



## Industrial & Commercial LED Lighting Company

4403 Greenbriar Dr, Stafford, Texas 77477  
Tel No. 1-800-8385070  
Monday - Friday 8:30 AM to 5:30 PM

# 623 SERIES AREA LED LIGHT



### Introduction:

- The 623 Series Selectable Area LED Light is the latest generation Area Light of DVDLights, it is highly cost effective, offers complete configurations.
- The 623 Series Selectable Area LED Light delivers 11000lm to 48000lm lumens, which can replace 250W to 1000W HID luminaires.
- The whole family includes three different size, Slipfitter mount, square or round pole mount arm and Yoke mount are available.
- Photocell, motion sensor and external light control shield are also available.

### Product Features:

- The 623 Series Selectable Area LED Light features a rugged die-cast aluminum body that uses a heatsink and flow-through venting to provide optimal thermal management, enhancing LED performance and extending component life.
- The light housing is sealed against moisture and environmental contaminants.
- 3G vibration rated compact design minimizes wind load requirements.
- Low EPA, allowing pole optimization.

### Electrical:

- Universal 120-277VAC, 120-347VAC or 277-480VAC input voltage
- Standard with 1-10V dimmable
- Power Factor :  $\geq 0.95$
- THD  $\leq 20\%$
- 10KV Surge Protector go standard
- Light engines are available in 3000K, 4000K, 5000K or 5700K (70 CRI) configurations

**Optics:**

- Type III,IV,V distributions optional

**Ambient Temperature:**

- -40° F (-40° C) to 113° F (45° C)

**Finishing:**

- Dark bronze is standard. black, white and grey optional

**Listing:**

- UL Cerfied to meet U.S. and Canadian standards.
- Suitable for wet locations.
- Rated for -40°C minimum<sup>®</sup> ambient.
- DesignLights Consortium (DLC) Premium qualified product and DLC qualified product.

**Accessories**

**Glare Shield**



External Half Glare Shield

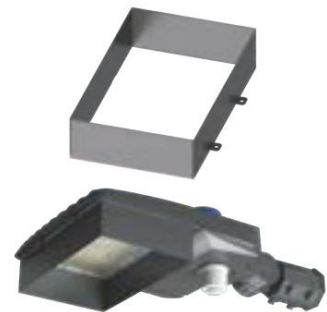

External 360 Full Visor

**Control Options**



**Photocell**

120-277V/120-347V/208-480V



**Shorting Cap**



**PIR Motion Sensor**

12V



**Surge Protection Device**

120-277V/347-480V

The SPD is included as standard for wattage from 150W and higher

**Accessories**

**Square & Round Pole Mount**

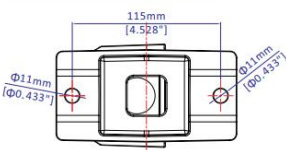

**Adjustable Square & Round Pole Mount**

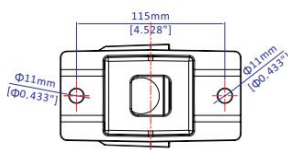

**Slip Fitter Mount**

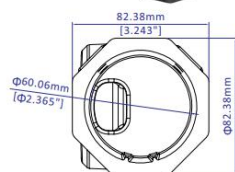

**Trunnion Mount**

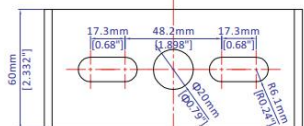

DVDLIGHTS - INDUSTRIAL & COMMERCIAL LED LIGHTING COMPANY - 623 SERIES CCT FIXED WATTAGE AREA LED LIGHT

Dimensions & Weight

80W/ 100W/120W/ 150W

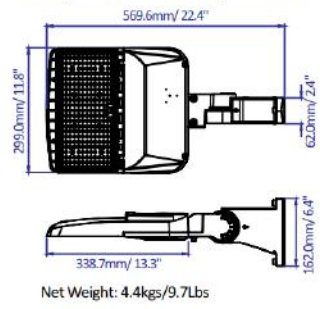

170W/ 200W /220W/ 240W

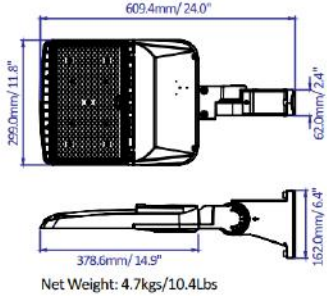

240W/ 260W /280W/ 310W

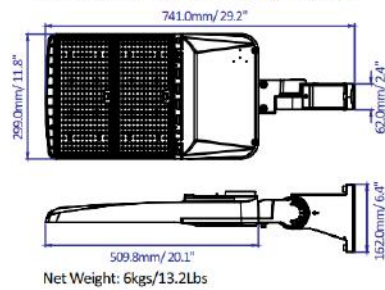

502.6mm/19.8"

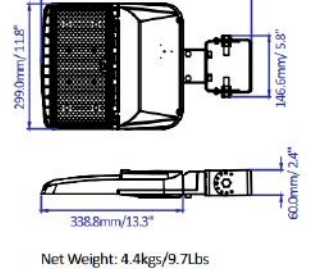

541.7mm/21.3"

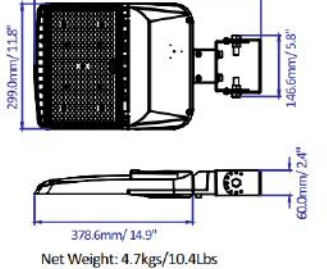

673.6mm/26.5"

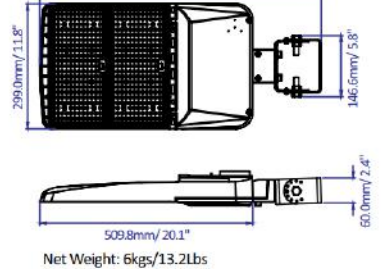

568.6mm/22.4"

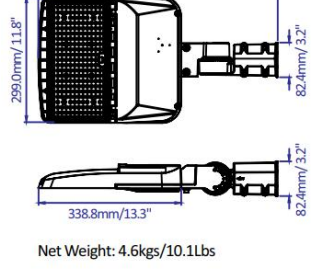

608.9mm/23.4"

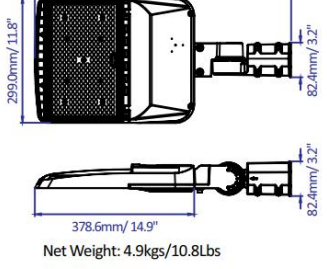

739.6mm/29.1"

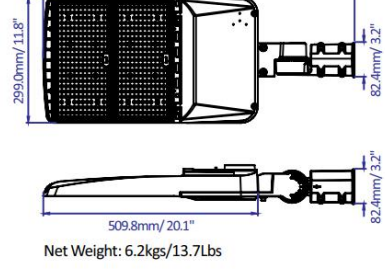

518.9mm/20.4"

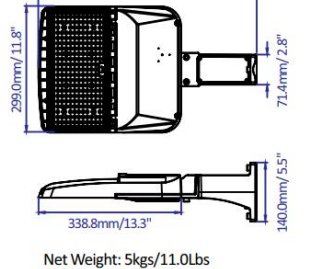

559.2mm/22.0"

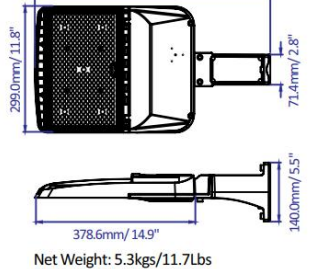

689.9mm/27.2"

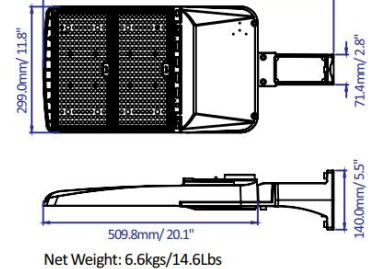

EPA (Square and Round Pole Arms)

Includes luminaire and integral mounting arm. Other tenons, arms, brackets or other accessories are not included in this EPA data

Mounting Type	Tilt	EPA(ft <sup>2</sup> )								
		Single	2@90	2@180	3@90	3@120	4@90	2 Side by Side	3 Side by Side	4 Side by Side
80W 100W 150W	0°	0.23	0.41	0.42	0.60	0.54	0.80	0.46	0.69	0.91
	10°	0.18	0.35	0.35	0.53	0.46	0.69	0.35	0.53	0.71
	20°	0.17	0.34	0.34	0.51	0.44	0.67	0.34	0.52	0.69
	30°	0.21	0.37	0.39	0.54	0.48	0.74	0.42	0.64	0.85
	40°	0.27	0.40	0.45	0.58	0.55	0.80	0.54	0.81	1.08
	45°	0.30	0.42	0.50	0.60	0.58	0.83	0.61	0.91	1.21
	50°	0.45	0.61	0.72	0.87	0.85	1.21	0.89	1.34	1.79
	60°	0.73	0.99	1.19	1.41	1.39	1.96	1.47	2.20	2.94
	70°	0.95	1.38	1.57	1.96	1.90	2.74	1.90	2.86	3.81
80°	1.13	1.71	1.89	2.45	2.36	3.40	2.26	3.40	4.53	
90°	1.28	1.99	2.18	2.86	2.77	3.96	2.57	3.85	5.14	

200W 240W	0°	0.25	0.44	0.46	0.65	0.58	0.87	0.50	0.75	0.99
	10°	0.19	0.38	0.38	0.57	0.50	0.75	0.38	0.58	0.77
	20°	0.19	0.37	0.37	0.55	0.48	0.73	0.37	0.56	0.75
	30°	0.23	0.40	0.43	0.59	0.53	0.80	0.46	0.69	0.92
	40°	0.29	0.44	0.49	0.63	0.60	0.87	0.59	0.88	1.17
	45°	0.33	0.45	0.54	0.66	0.63	0.90	0.66	0.99	1.32
	50°	0.49	0.66	0.79	0.95	0.93	1.31	0.97	1.46	1.94
	60°	0.80	1.08	1.29	1.54	1.51	2.13	1.60	2.39	3.20
	70°	1.04	1.50	1.70	2.13	2.07	2.97	2.07	3.11	4.14
	80°	1.23	1.86	2.05	2.66	2.57	3.70	2.46	3.69	4.92
310W	0°	0.35	0.62	0.64	0.91	0.82	1.21	0.69	1.04	1.39
	10°	0.27	0.54	0.53	0.80	0.69	1.06	0.54	0.81	1.08
	20°	0.26	0.52	0.52	0.77	0.67	1.02	0.52	0.79	1.05
	30°	0.32	0.56	0.60	0.83	0.74	1.12	0.64	0.97	1.29
	40°	0.41	0.61	0.68	0.88	0.84	1.21	0.82	1.23	1.64
	45°	0.46	0.63	0.76	0.92	0.89	1.26	0.92	1.38	1.85
	50°	0.68	0.93	1.10	1.32	1.30	1.84	1.36	2.04	2.72
	60°	1.12	1.51	1.81	2.15	2.12	2.99	2.24	3.35	4.47
	70°	1.45	2.09	2.38	2.99	2.90	4.16	2.90	4.35	5.79
	80°	1.72	2.60	2.88	3.72	3.60	5.18	3.44	5.17	6.89
90°	1.95	3.02	3.32	4.35	4.22	6.03	3.91	5.86	7.82	

Photometric Diagrams

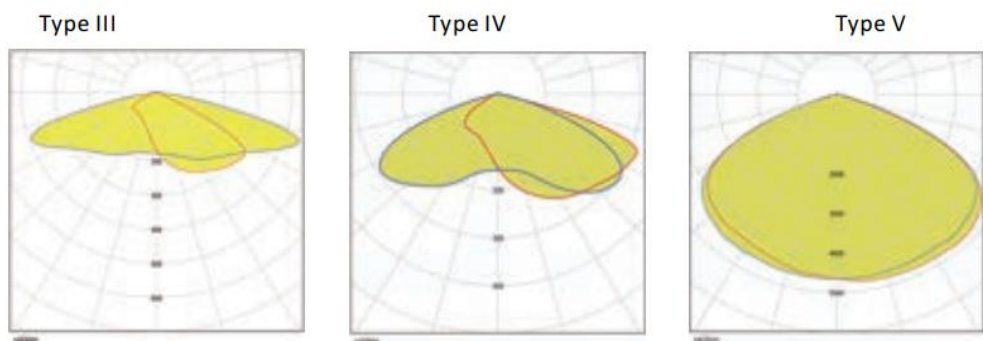

Isofootcandle plots for the 150W-5000K. Distances are in units of mounting height(30')

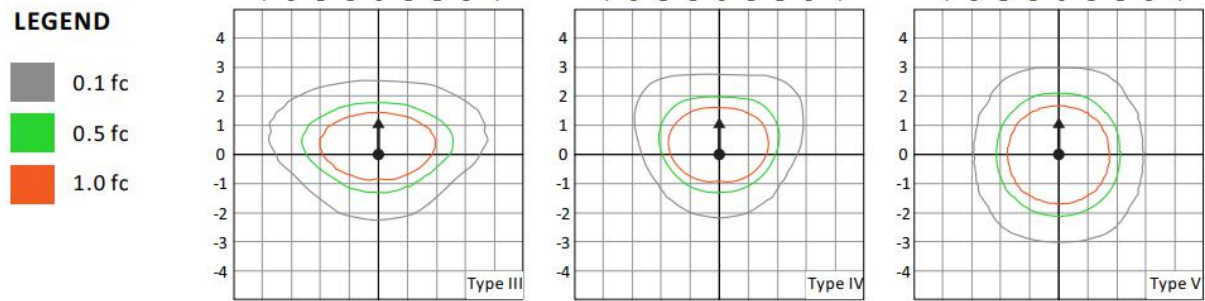

Specification

System Watts	Voltage	Distribution Type	4000K/5000K/5700K, 70CRI					3000K, 70CRI				
			Lumens	B	U	G	LPW	Lumens	B	U	G	LPW
80W	120-277V	T3	12,240	3	0	3	153	11,077	3	0	3	138
		T4	12,080	3	0	2	151	10,932	3	0	2	137
		T5	12,400	3	0	1	155	11,222	3	0	1	140
	120-347V	T3	12,400	3	0	3	155	11,222	3	0	3	140
		T4	12,240	3	0	2	153	11,077	3	0	2	138
		T5	12,560	3	0	1	157	11,367	3	0	1	142
	277-480V	T3	12,240	3	0	3	153	11,077	3	0	3	138
		T4	12,080	3	0	2	151	10,932	3	0	2	137
		T5	12,400	3	0	1	155	11,222	3	0	1	140
100W	120-277V	T3	15,300	3	0	3	153	13,847	3	0	3	138
		T4	15,100	3	0	2	151	13,666	3	0	2	137
		T5	15,500	3	0	1	155	14,028	3	0	1	140
	120-347V	T3	15,500	3	0	3	155	14,028	3	0	3	140
		T4	15,300	3	0	2	153	13,847	3	0	2	138
		T5	15,700	3	0	1	157	14,209	3	0	1	142
	277-480V	T3	15,300	3	0	3	153	13,847	3	0	3	138
		T4	15,100	3	0	2	151	13,666	3	0	2	137
		T5	15,500	3	0	1	155	14,028	3	0	1	140

DVDLIGHTS - INDUSTRIAL & COMMERCIAL LED LIGHTING COMPANY - 623 SERIES CCT FIXED WATTAGE AREA LED LIGHT

150W	120-277V	T3	22,650	3	0	3	151	20,498	3	0	3	137
		T4	22,350	3	0	3	149	20,227	3	0	3	135
		T5	22,950	4	0	2	153	20,770	4	0	2	138
	120-347V	T3	22,950	3	0	3	153	20,770	3	0	3	138
		T4	22,650	3	0	3	151	20,498	3	0	3	137
		T5	23,250	4	0	2	155	21,041	4	0	2	140
	277-480V	T3	22,650	3	0	3	151	20,498	3	0	3	137
		T4	22,350	3	0	3	149	20,227	3	0	3	135
		T5	22,950	4	0	2	153	20,770	4	0	2	138
200W	120-277V	T3	30,400	4	0	4	152	27,512	4	0	4	138
		T4	30,000	4	0	3	150	27,150	4	0	3	136
		T5	30,800	5	0	2	154	27,874	5	0	2	139
	120-347V	T3	30,800	4	0	4	154	27,874	4	0	4	139
		T4	30,400	4	0	3	152	27,512	4	0	3	138
		T5	31,200	5	0	2	156	28,236	5	0	2	141
	277-480V	T3	30,400	4	0	4	152	27,512	4	0	4	138
		T4	30,000	4	0	3	150	27,150	4	0	3	136
		T5	30,800	5	0	2	154	27,874	5	0	2	139
240W	120-277V	T3	36,240	4	0	4	151	32,797	4	0	4	137
		T4	35,760	4	0	3	149	32,363	4	0	3	135
		T5	36,720	5	0	2	153	33,232	5	0	2	138
	120-347V	T3	36,720	4	0	4	153	33,232	4	0	4	138
		T4	36,240	4	0	3	151	32,797	4	0	3	137
		T5	37,200	5	0	2	155	33,666	5	0	2	140
	277-480V	T3	36,240	4	0	4	151	32,797	4	0	4	137
		T4	35,760	4	0	3	149	32,363	4	0	3	135
		T5	36,720	5	0	2	153	33,232	5	0	2	138
310W	120-277V	T3	46,810	4	0	4	151	42,363	4	0	4	137
		T4	46,190	4	0	3	149	41,802	4	0	3	135
		T5	47,430	5	0	2	153	42,924	5	0	2	138
	120-347V	T3	47,430	4	0	4	153	42,924	4	0	4	138
		T4	46,810	4	0	3	151	42,363	4	0	3	137
		T5	48,050	5	0	2	155	43,485	5	0	2	140
	277-480V	T3	46,810	4	0	4	151	42,363	4	0	4	137
		T4	46,190	4	0	3	149	41,802	4	0	3	135
		T5	47,430	5	0	2	153	42,924	5	0	2	138

## Ordering Guide

### Example:

- **642C2-150W** (WITH SHORTING CAP)
- **642C2-150WN** (NOT PHOTOCELL CAPABLE)
- **623-SLIP**

PRODUCT TYPE	PRODUCT NAME	CCT	INPUT VOLTAGE	WATTAGE	PHOTOCELL	ADD ON
AREA / POLE LIGHT FIXTURE	623	C=5000K D=4000K X=30/40/50K	2 = 120-277V 7=277-480V	150W = (80/100/120/150)W 240W = (170/200/220/240)W 310W = (240/260/280/310)W	BLANK = WITH SHORTING CAP N= NOT PHOTOCELL CAPABLE	PHOTOCELL = 523C2-PHOTOCELL NA
AREA / POLE LIGHT MOUNT	623	SLIP FITTER TRUNNION EXTRUSION = ADJUSTABLE DIRECT ARM MOUNT EXTRUSION-C = FIXED 90 DEGREE DIRECT MOUNT				